

USER'S MANUAL

Automatic intelligent optical fiber fusion splicer

2019.05

CATALOGUE

Safety Requirements	_____	1
Warnings	_____	3
Precautions	_____	5
Chapter I		
Operation Keys And Parts Introduction	_____	7
Display Menu Introduction	_____	9
Introduction To Splice Interface	_____	12
Chapter II		
Software download	_____	14
Software bluetooth connection	_____	15
Screen Menu Function On/off	_____	19
Chapter III Toolbox Introduction	_____	21
Chapter IV ARC Calibration	_____	22
Chapter V Fiber stripping and put into holder	_____	25
Chapter VI Replace Electrode	_____	27
Chapter VII Activate Electrode	_____	31
Chapter VIII Smart Lock	_____	34
Chapter IX Replace FC tank	_____	36
Chapter X Daily Maintenance	_____	38

SAFETY REQUIREMENTS ▼

At any stage of operation on the optical fiber fusion splicer, you must take the following general safety precautions. Not take these warnings and precautions or not comply with the warnings which described in this manual, would violate the fusion splicer design, manufacture and use of safety standards. My company does not assume any responsibility for the consequences of breaching these requirements for users caused!

Operation environment and Power

Fusion splicer operation, storage environment and working power requirements

Operating temperature: 0 ~ +40 °C

Limit temperature: -10 °C ~ +50 °C

Operating humidity: 95% RH or less (no condensation)

Maximum wind speed: 15m/s

Storage conditions: -20 °C ~ +60 °C (no condensation)

Before turning on the power, please make sure that the power supply can match its voltage, and that all safety measures are taken.

- Do not use the fusion splicer in explosive environments.
- Do not use the fusion splicer in the presence of flammable gases or fumes
- Do not attempt to disassemble any of the components of fusion splicer

SAFETY REQUIREMENTS ▼

In addition to the statements in this manual to allow user-replaceable parts, please do not attempt to disassemble any of the components of fusion splicer. Replacement parts and internal adjustments can only be commissioned by authorized service personnel.

WARNINGS ▼

• AC/DC Adapter

The output characteristics of the power adapter must meet the following requirements.

Voltage: 13V ~ 14V;

Current: $\geq 4A$;

Polarity: Center is positive.

Using higher voltage will cause damage to the fusion splicer. AC / DC power adapter input AC voltage of 100 ~ 240V, 50/60Hz, if input voltage exceeds this range may cause permanent damage to the adapter!

• Internal lithium battery

There is a lithium-ion battery cells in the fusion splicer, the use of other batteries may damage the fusion splicer and jeopardize personal safety.

For safety sake, lithium battery pack can not be disassembled to prevent short circuits; do not crash battery, do not let the battery close to a fire or an excessive heat to prevent lithium battery explosion.

• Operation on optical fiber fusion splicer

When below situation happens on fusion splicer, please turn off the fusion splicer immediately and unplug the power adapter from the power input, otherwise it will cause the fusion splicer may not work properly or can not be repaired and other serious consequences.

WARNINGS ▼

Liquid, foreign substances enter the interior of fusion splicer

Fusion splicer subjected to strong vibrations and shocks

There is no necessary parts that need to maintain inside the fusion splicer, it is forbidden to dismantle the fusion splicer, any dismantlement may result in personal injury or equipment can not be repaired

PRECAUTIONS

The AI-7 and AI-8 firmware (v1.6) mainly adds the following features:

1. Added smart lock function.
2. 15 seconds after the end of splicing, you can press the ARC button to add a discharge.
3. When the fiber image quality, end face or angle is unqualified, you can press the Continue button to forcibly splice again, but the splicing quality can not be guaranteed.

PRECAUTIONS ▼

• AC/DC Adapter

Please use the provided adapter for the fusion splicer, use of other adapters may cause damage to the fusion splicer.

• Internal Lithium Battery

1. The battery may go into hibernation after long time placed, the capacity is lower than normal at this time, the durable battery time has also come to be shortened, but only after 2 to 3 times of normal charge-discharge cycles, the battery can be activated to restore normal capacity. Lithium has almost no memory effect, can be charged at any time.

2. The lithium battery has the phenomenon of self-discharge, if the battery is preserved for a long time in low battery power, the internal structure of the battery may be damaged from self-discharge, reducing battery life. Therefore, long-term preservation of lithium batteries please recharge it every 3 to 6 months, pay attention to the battery charge capacity can be 60% to 80%, not full.

3. Long-term storage battery (stored for more than 6 months) temperature range: 0 °C ~ 40 °C.
Battery short-term storage (storage time is less than or equal to 6 months) temperature range: -20 °C ~ 60 °C

4. To ensure that the security of battery charging, the lithium battery in the fusion splicer is charging temperature range of 0 °C ~ 40 °C

PRECAUTIONS ▼

• LCD Display

1. Please do not let sharp object click on the LCD display, LCD display can not be forced shock

2. Do not use organic solvents or contaminants dripping on the LCD display, such as acetone, oil, antifreeze, grease, etc., otherwise may cause the LCD display not working.

3. Use silk or soft fabric to wipe & clean the LCD display.

4. Depending on the perspective of the viewing screen, the brightness of the display will be different. But may also have some black, red, blue or green dots on the screen, these are not the fault of the LCD display, it is normal phenomenon.

• The use of fusion splicer

1. Fusion splicer is for splicing silica glass fiber, please do not use this equipment for other purposes. Please read this manual carefully before using

2. When used in dusty environments, please try to keep the windshield to be closed on fusion splicer.

3. When fusion splicer machine moved from a cold to a high temperature environment, please try to take a gradual warming way, otherwise it will cause condensation inside the instrument, it will have an adverse effect on the instrument.

4. Fusion splicer machine is a calibrated precision instrument, it is strongly advised to avoid vibration and shock. Storage should be used with a dedicated carrying case, long-distance transportation needs to pack a carrying case outside plus a suitable buffer box.

Operation keys and parts introduction

The fusion splicer machine is mainly used for permanent splicing fiber, the machine can continue to splice ordinary rubber insulated fiber cable, jumper wire and a cladding diameter of 80 μ m ~ 150 μ m, single mode, multimode and other quartz-based dispersion shifted fiber. The operation process should be taken to keep clean, free subjected to strong vibration or shock.

RESET

Press the reset key to reset the propulsion motor, adjustable motor, and focusing motor to their original. When the Reset button light is on, it indicates the reset is in process. If it turns off within 5 seconds automatically that means the reset is successful, otherwise the reset is failed

CONTINUE

When the pause function is on, please press the CONTINUE key to continue the next operation.

X, Y DISPLAY TOGGLE KEY

X, Y display toggle

POWER

Long press to turn on or off.

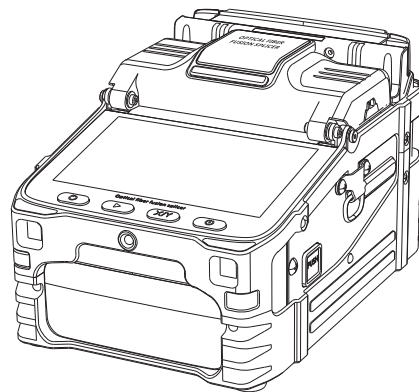

Function description table

Number	Name	Function description
1	Power Outlet	Input voltage 13.5 \pm 0.5V; input current \geq 4A
2	Battery popup button	Press to remove the battery
3	Heating indicator	When shrinkable tube heating is complete, the indicator light is off
4	Heating tank	Put shrinkable tube in it, close the lid and automatically heat

DISPLAY MENU INTRODUCTION ▾

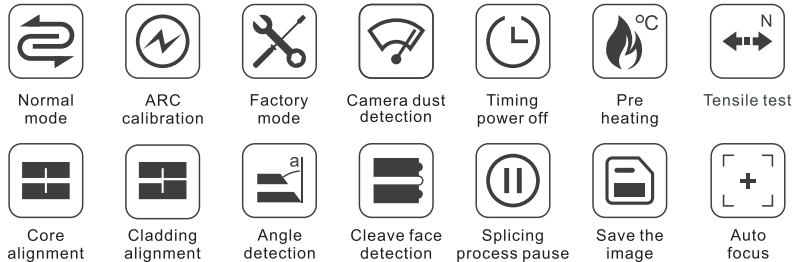

DISPLAY MENU INTRODUCTION ▾



Normal mode : Normal splicing mode for the machine



ARC calibration : According to the altitude, temperature, humidity and other conditions of the user, match the most suitable ARC discharge value to minimize the splicing loss



Factory mode : Can adjust the fiber manually, align fiber, focus fiber, splice fiber and other operations



Camera dust detection : The splicer machine scans the camera image by line and column automatically. When there is interference point that will affect the image recognition, the screen will mark the specific location. If everything is normal, the screen will be blank and no mark



Timing power off: machine will automatically shut down when it continues to exceed the set time.



Pre heating : When the function is turned on, and for each time once the splicing is successful, the heater will automatically start for 6 seconds from the time of opening the windshield cover



Tensile test : When the function is turned on, the tensile test is performed after each successful splicing.

DISPLAY MENU INTRODUCTION ▾



Core alignment : Fiber splicing is based on core alignment



Cladding alignment : Fiber splicing is based on cladding alignment



Angle detection : When the function is turned on, if the fiber cleaving angle is greater than the upper limit value (upper limit value can be set in the "Splicing settings" menu "Cleave angle upper limit"), the splicing machine will pause and report the error.



Cleave face detection : If the cleaving end face quality of the fiber does not meet the set parameters (end face quality requirements can be set in the "Splicing settings" menu "End face quality"), the splicing machine will pause and report the error.



Splicing process pause : When the function is on, the splicing machine will stop the final splicing process after in the completion of the fiber focus, end face detection and fiber alignment. Please then press the "Continue" button to perform the ARC discharge and the subsequent splicing process. If the cleave face detection is not passed, it will pause and report the error, then please press the "continue" key to ignore the error and continue the follow-up process



Save the image : When the function is turned on, it will save the splicing image when the splicing failed. It will not save the splicing image when the splicing is successful or this function is closed.



Auto focus : When the function is turned on, for each time splicing it will adjust the camera focal length to the set target value automatically (target value in the "Splicing settings" menu set "focus target value")

INTRODUCTION TO SPLICE INTERFACE ▾

The screenshot shows the splicing interface with the following labels and corresponding elements:

- X screen display**: Points to the top status bar showing time (15:11), fiber mode (SM), and heating time (20s).
- Fiber mode**: Points to the 'SM' indicator.
- Left and right angle**: Points to the top part of the fiber image.
- Left end face angle**: Points to the left side of the fiber image.
- Y screen display**: Points to the middle status bar showing '0.0', '0.0', '0.0', and '0.01dB'.
- Splice status remind**: Points to the bottom part of the fiber image.
- Heating time**: Points to the '20s' indicator.
- Bluetooth**: Points to the Bluetooth icon.
- Right end face angle**: Points to the right side of the fiber image.
- Splicing loss**: Points to the '0.01dB' indicator.
- Number of electrodes remain**: Points to the 'Remain: 2975' indicator.
- Total splicing**: Points to the 'Total: 3025' indicator.
- Smart tips**: Points to the bottom status bar containing icons for Camera failure, Core align failed, Focus failed, ARC calibration failed, Left and right fiber does not match, and The lens is foggy or foreign body interference.

INTRODUCTION TO SPLICE INTERFACE



Flash on both sides
please place fiber



Left fiber is too long
(also adapted to right)



Left fiber is too short
(also adapted to right)



Left end face is unqualified
(also adapted to right)



Detection fiber qualified



If the qualified fiber is not recognized
or the fiber is not detected, please
clean the V-groove and reposition it.

Fiber status prompt description

CHAPTER II

Software download

中国地区：扫描二维码或进入苹果商店搜索“灼识掌中宝+”下载手机APP亦可进入网址 www.sczhuoshi.com的“软件下载”里面直接下载。

Outside China: Go to Google Play or App Store and search for "Signalfire2", download Phone App.



Google play



App store



Scan QR code

SOFTWARE BLUETOOTH CONNECTION ▾

The splicing operation does not require phones, the phone App is only for machine menu settings, and splicer machine to store data when the data is exported to phone App, the users can also get support through the APP and after-sales service.

Phone settings

1. Apple phone (IOS system) to turn on Bluetooth permissions

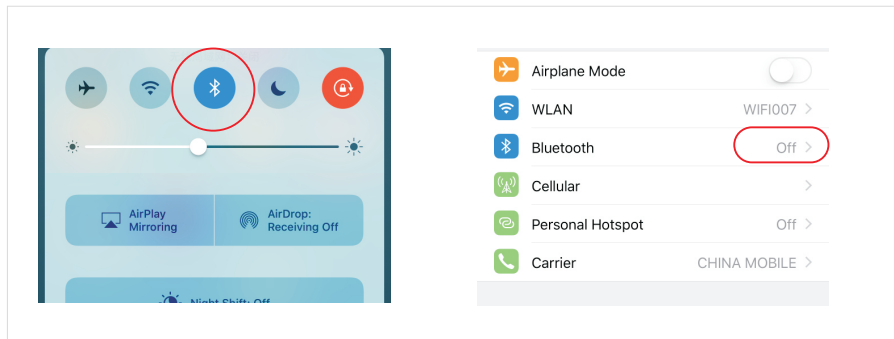

SOFTWARE BLUETOOTH CONNECTION ▾

2. Android phone to open the Bluetooth permission function is as follows:

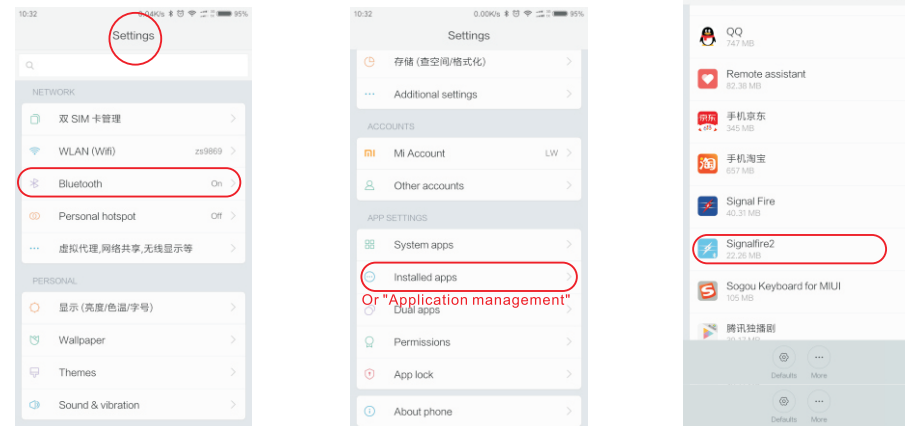

1. Turn on phone settings then turn on Bluetooth

2. Return to the settings interface, choose "more applications or application management".

3. Select "signalfire2" in the list

SOFTWARE BLUETOOTH CONNECTION ▾

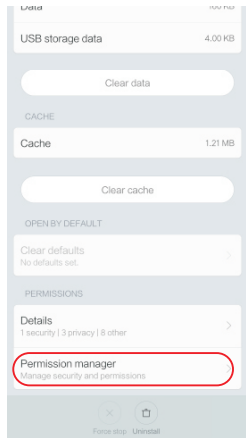

4. Select Rights Management

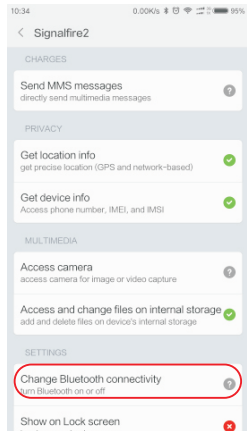

5. Select to turn on Bluetooth, turn on Bluetooth permissions

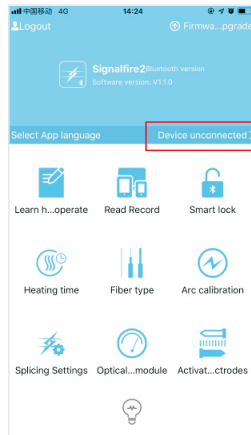

6. login app account and connect Bluetooth on splicer, click "Device unconnected"

SOFTWARE BLUETOOTH CONNECTION ▾

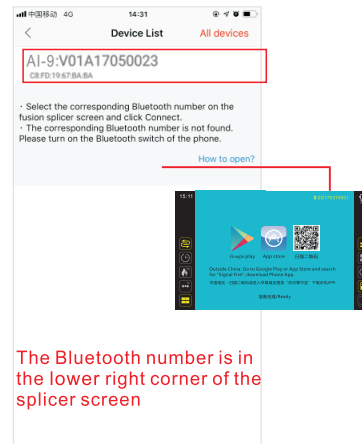

The Bluetooth number is in the lower right corner of the splicer screen

7. Please select the corresponding splicer serial number and click on, if you can not find the splicer serial number, please check whether the Bluetooth or GPS is turned on

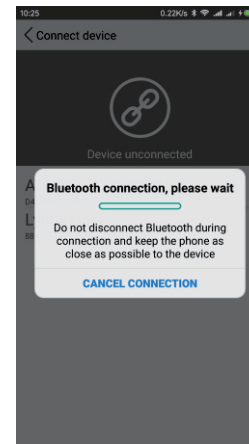

8. Connecting...

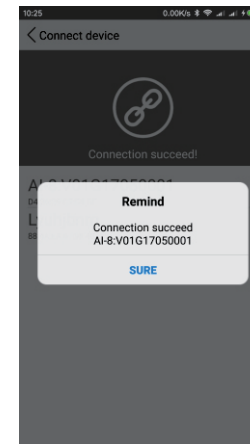

9. Connect successfully

SCREEN MENU FUNCTION ON/OFF

Turn on the phone Bluetooth, open the phone app, set the machine panel menu after establishing the connection, and machine will update at the same time. **The splicing operation does not require phones**, the phone App is only for machine menu settings, and splicer machine to store data when the data is exported to phone App, the users can also get support through the APP and after-sales service.

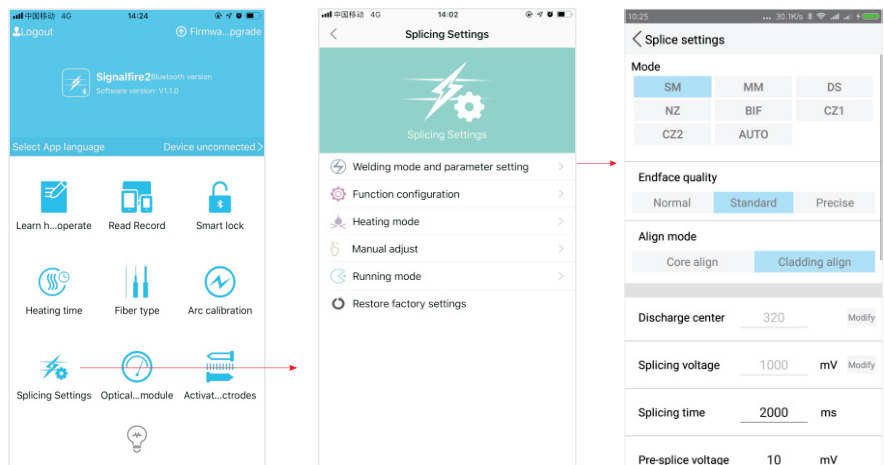

Select and click Save

SCREEN MENU FUNCTION ON/OFF

When the settings are saved, the display icon will be highlighted / darkened accordingly, otherwise please check whether the Bluetooth is properly connected.

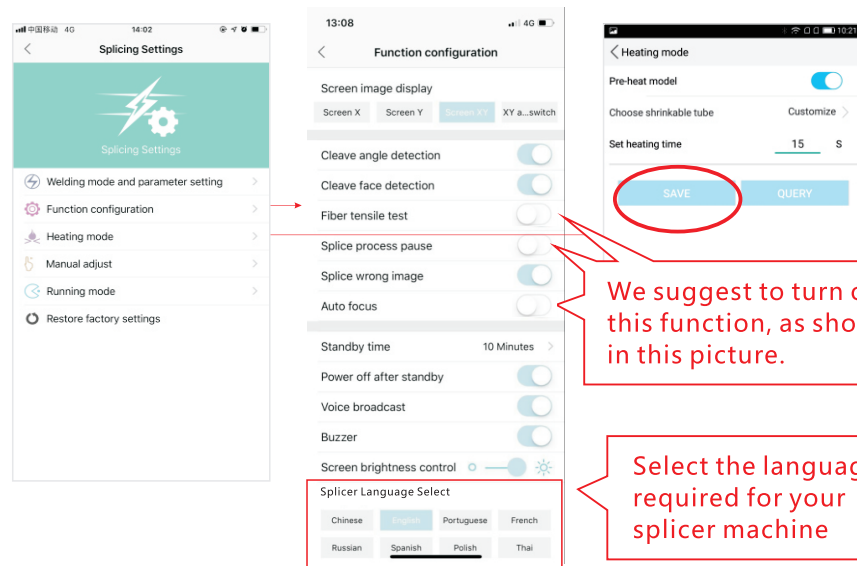

CHAPTER III TOOLBOX INTRODUCTION ▼

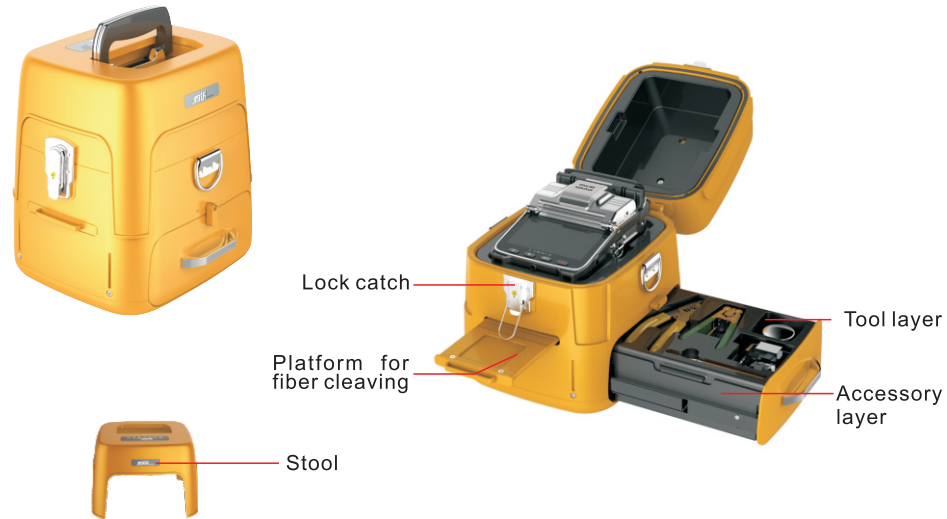

CHAPTER IV ARC CALIBRATION ▼

ARC Calibration : According to the local ground elevation, temperature, moderate and other environmental factors to match the most suitable discharge ARC, in order to obtain the best splicing effect, we strongly recommend you to do ARC calibration when it is the first time to use the new machine, the seasonal changes, the use place changes, or you replaced the electrodes.

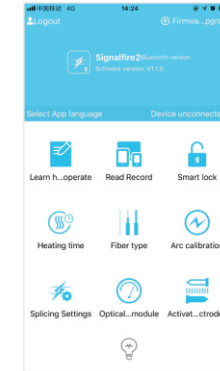

The procedure for ARC Calibration is as follows:



Step 1: Please turn on the splicer machine, then login "Signalfire2" on your phone, connect the Bluetooth, open the ARC Calibration (See picture)





ARC CALIBRATION ▾



Step 2: After open the ARC Calibration, the icon of "Normal Mode"  will change to the icon for "ARC Calibration" . Then please strip and cleave the fiber, place the fiber to fiber holder and close the windshield cover, the splicer machine will perform the ARC calibration automatically. (See picture)

ARC CALIBRATION ▾



Step 3: There is flash on the display screen and slight burst from the ARC, the fiber head is burning into a spherical shape, the action stops after the screen icon "  " change back to "  " icon (see picture), it shows the ARC calibration is successful. If the icon does not change back to the "Normal Mode"  " icon, the screen  fiber still flashes, please re-cleave the fiber and repeat the above steps until the ARC calibration is successful.

CHAPTER V FIBER STRIPPING AND PUT INTO HOLDER ▾

Cleave fiber instructions:

Jumper fiber (pigtail fiber)

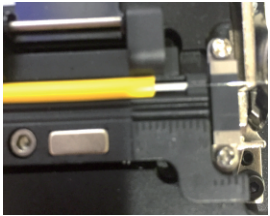

With the yellow plastic layer as the boundary, the scale is between 16 to 18, the white skin layer should be longer than the yellow layer of about 5mm, placed it in the scale 10-12 or so (near the rubber pad about 2mm or less)

Rubber insulated fiber

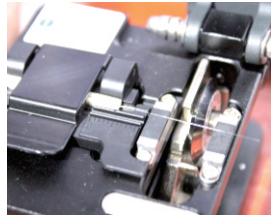

Scale is between 16 to 18

Bare fiber

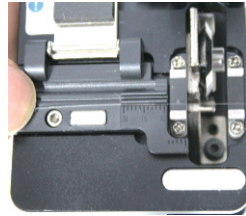

To the cladding layer, the scale is between 10 to 12

FIBER STRIPPING AND PUT INTO HOLDER ▾

Instructions for put fiber into holder:

Pigtail fiber/jumper fiber

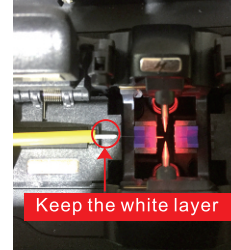

Rubber insulated fiber

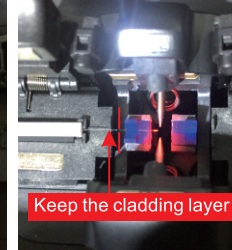

Cable/bare fiber

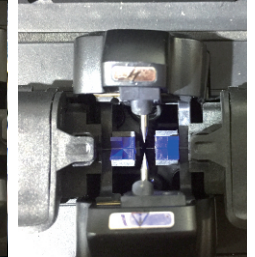
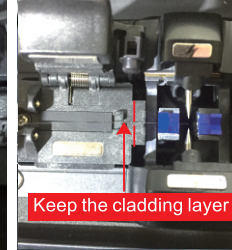

Remark:

1. Please make sure you place the fiber into the blue V-groove, the tip of the fiber is close to the center of the electrode. If the fiber is too far from the electrode center, it will remind you to re-place it.
2. The tip of the fiber must not exceed the center of electrode.

CHAPTER VI REPLACE ELECTRODE ▼

Electrode replacement must use the genuine & original electrode designed for this machine from factory. When the number of electrode is used close to 3000 times, the machine will remind you to replace it. When it reaches to 3000 times, it is necessary to replace the electrode and activate it then you can use again (see page 38 ACTIVATE ELECTRODE). Otherwise it may affect the splicing quality, or even shut down the program automatically, and could not splice.

The electrode replacement procedure is as follows:

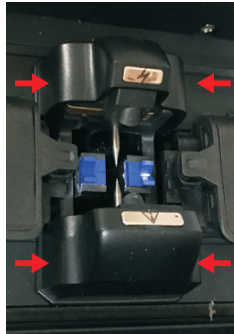

1. Please pinch the electrode cover on both sides slightly, see the location in picture, then remove up the electrode cover.



2. The cap size of two electrodes is different, wider head is for the electrode which is close to screen direction.

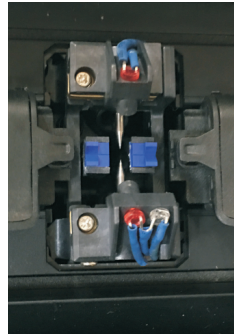

3. Take away the cover, as shown in picture

REPLACE ELECTRODE ▼

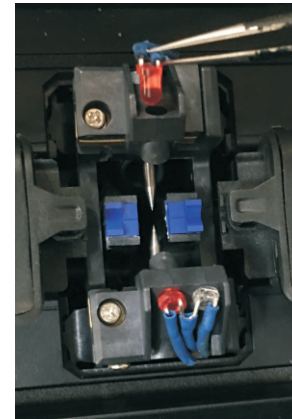

4. Remove the lamp cap on both sides with tweezers



5. Screw out the screws with a screwdriver

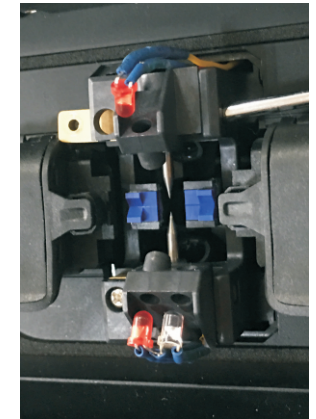

6. Use a screwdriver to push out the latch and remove the electrode. remove the another electrode by the same way

REPLACE ELECTRODE ▼

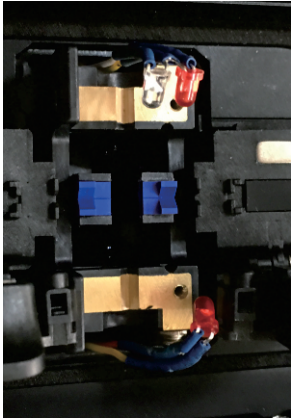

7. Two old electrodes are removed

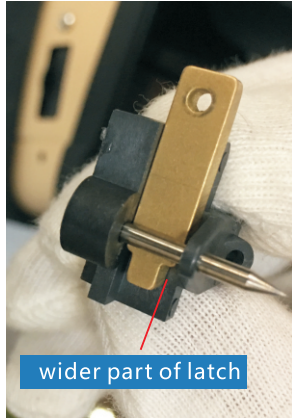

8. Replace the new electrodes and put the latch, the wider part of the latch is toward to the electrode needle

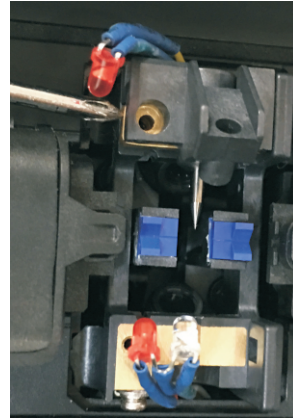

9. Push the latch and install the screw

REPLACE ELECTRODE ▼

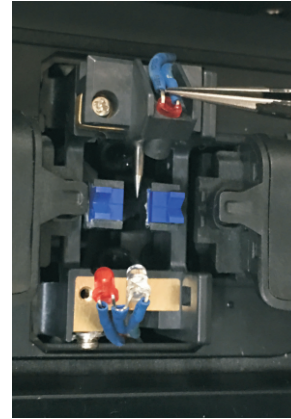

10. Use tweezers to put the lamp into the original hole

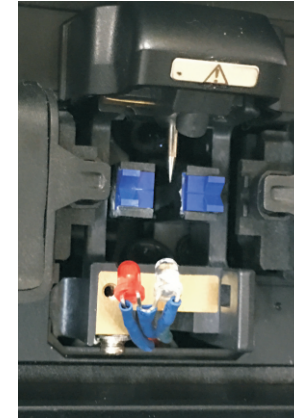

11. Close the electrode cap. Replace the other electrode by the same way



12. Close the electrode cap, electrode replacement is complete

CHAPTER VII ACTIVATE ELECTRODE ▼

P.S. The electrodes on the new machine do NOT need to activate, we have activated it before ex-factory. Only when the electrodes life on the machine is expired in the future and then you need to replace & activate the electrodes.
When the electrode is used up to 3000 times, you need to replace the electrode and activate it .You need to use APP software "Signalfire2" install in your phone and activate the electrodes.
Please scan the two-dimensional code on the machine screen to download the APP software.

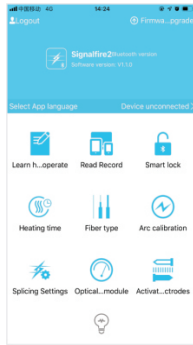

1. Open the "Signalfire2" APP software, click on login

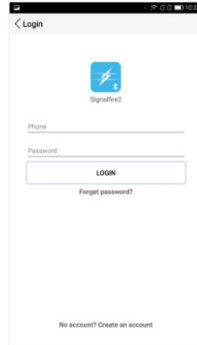

2. Please log in directly if you have an account, otherwise please register first

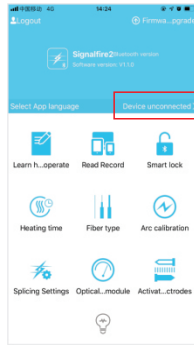

3. Click "Device unconnected" after login is successful

ACTIVATE ELECTRODE ▼

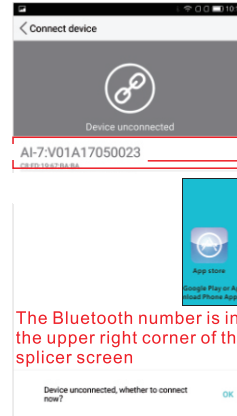

The Bluetooth number is in the upper right corner of the splicer screen



4. Please select the corresponding Bluetooth number and click on, if you can not find the Bluetooth number, please check whether the Bluetooth or the machine power is turned on

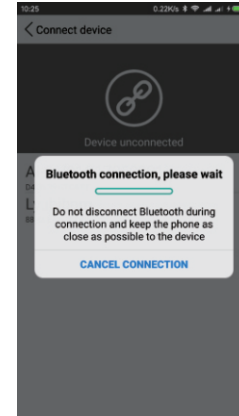

5. Connecting

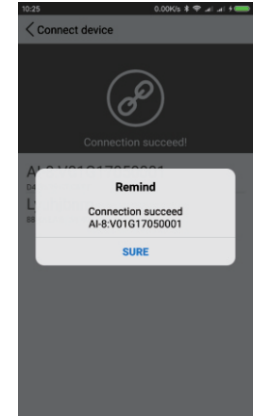

6. Connected successfully

ACTIVATE ELECTRODE

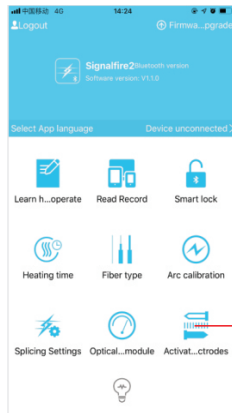

7. Back to the home page, click on "Activate Electrode"

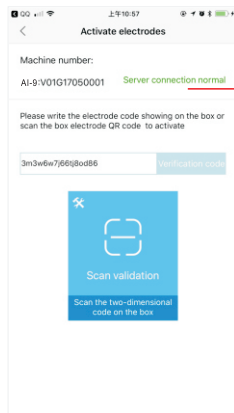

8. Enter the number of the two-dimensional code on the electrode box (please distinguish between numbers and letters) or scan the two-dimensional code on the electrode box

If the server connection fails, please check and reconnect to the network.

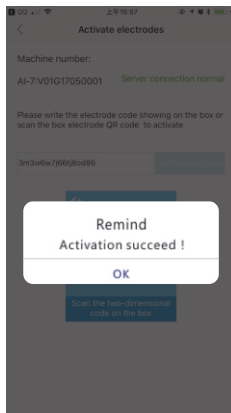

9. Activation is successful, please restart the machine

CHAPTER VIII SMART LOCK

Smart Lock Purpose: to facilitate management or owner's effective management of the splicer machine's use period or the number of splicing. Typical applications such as rental business.

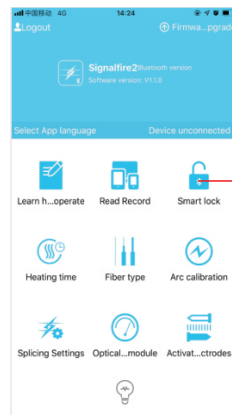

1. After the Bluetooth connection between the mobile phone and the fusion splicer is successful, click on the smart lock to enter

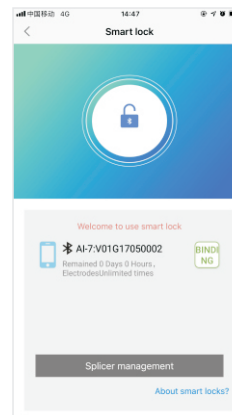

2. After binding is clicked, this mobile phone account has unique control over this splicer.

SMART LOCK

A device can only be bound to one mobile account at the same time. To bind other mobile phones, you need to unbind current account first.

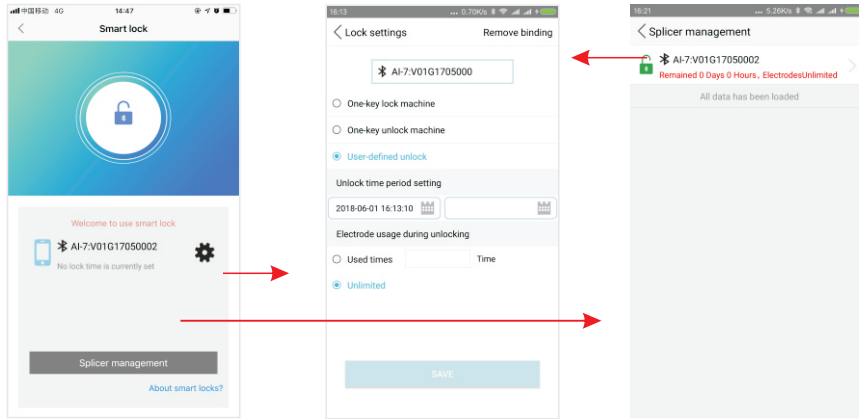

3. Click on the settings icon to enter.

4. Save after personalization settings.

5. Click on the "Smart lock management" button to see all the splicing machines controlled by this mobile phone account.

*CHAPTER IX REPLACE FC TANK

To use the heating tank for FC connector, you need to replace the corresponding parts, the operation is as shown in picture.



1. Use a screwdriver to remove the two screws on the left side of the heating tank

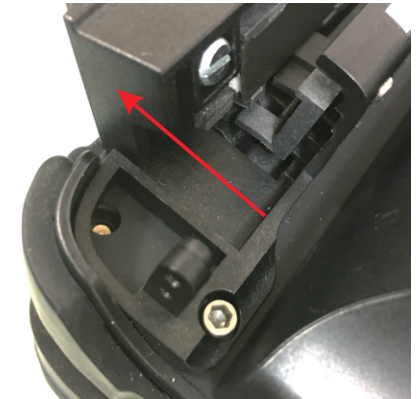

2. Extract it by hand, extraction process is with appropriate force (See picture)

*Note: The standard packing does not provide the accessories, please contact the supplier if necessary.



3. Align the new head to the red dotted line position, and then you can press alignment.



4. Replace the screws tightened, finished the process.

1 Pay attention to dustproof and remove dust

Bare fiber positioning groove, electrodes and microscopes must be kept clean and windshield cover should be closed when not in operation

1. V-groove Cleaning

If the V-groove has dirty and can not hold the fiber properly, which will cause very high splicing loss. Thus in the daily work, you should always check the V-groove and regular cleaning V-groove. Follow the steps below to clean the V-groove.

- (1) Open the windshield cover;
- (2) Use a cleaved fiber tail in one direction push the pollutants and remove from the V-groove;
- (3) If the fiber can not clear the V-groove pollutants, then moistened with alcohol cotton swab to clean the bottom of the V-groove, and use a dry cotton swab to wipe off the extra alcohol in the V-groove.

2. Cleaning and replacing the electrode

If the electrode is dirty, you can clean electrode by using the cleaning electrode function in main menu in the equipment maintenance, and then use a cotton swab dipped in alcohol to gently wipe the electrode tip, or use 3mm wide, 50mm long metallographic sandpaper to gently rub the electrode tip. Note To protect the electrode tip from damage.

3. If the objective lens is dirty, the normal position of the observation optical fiber core may be affected, which leads to a higher splice loss or poor fusion. So you should regularly clean two objective lenses, otherwise it will continue to accumulate dust and ultimately can not be removed.

DAILY MAINTENANCE ▼

Follow the steps below to clean the objective lens :

- (1) Before cleaning the objective lens, please must turn off the power.
- (2) Use cotton swab moistened with alcohol to gently wipe the objective lens. Beginning with a cotton swab to wipe from the middle of the lens, do a circular motion, until the edges of the lens spin out. Then wipe with a clean, dry cotton swab to remove extra alcohol.
- (3) Turn on the power, make sure that the display is not visible dust and stripes.

2 Prevent Strong Shock or Vibration

When you need to move or transport the fusion splicer, you should handle with care and gently. In addition, do not forget to put the machine into a carrying case and shipping box during long-distance transportation.

3 Storage

When you do not use the machine for a long time, please must turn on the machine once half a year. Especially in high moisture season, should always be turned on, and the desiccant should be placed inside the carry case to prevent mildew microscope head.

4 Precautions

1. When the fusion splicer is using AC power , please take attention to protect the adapter , and the power supply is properly grounded.
2. When the fusion splicer is in the ARC discharge process, there are several kilovolt high voltage between the electrodes, please do not touch the electrode rod at this time!

DAILY MAINTENANCE ▼

3. Please be sure that there is no gasoline, mashgas, freon gas and other flammable gas in the environment and, so as not to lead to poor fusion or accident.

4. When you wipe to clean the fiber holder and microscope head, please must use absolute ethanol, cotton swab to wipe the direction should be one-way, two-way wipe is forbidden.

5. There are many mechanical components in the fusion splicer with structural precision, in addition to the electrodes, the other part is prohibited for user disassemble and change. Because these mechanical parts are precision-machining and calibration, once there is any changes, it is difficult to return to its original position. You can replace only the electrode-yourself.

The objective lens, V-groove, display screen, etc should be kept clean. Clean only with absolute ethanol, you can not use other chemicals.

5 Troubleshooting and solutions

The table lists a general troubleshooting method for the user reference. When the user can not solve the situation, please contact with the suppliers directly.

Troubleshooting	Reason	Solutions
No image after placing fiber	<ol style="list-style-type: none"> 1. Not power on 2. Fiber does not enter V-groove or V-groove has dirty 3. The length of the fiber is too short or broken 4. The align mechanism is not initialized 5. No signal detected for close windshield cover 	<ol style="list-style-type: none"> 1. Press the power key 2. Re-place the fiber or brush the V-groove with alcohol 3. Re-cleave the fiber 4. Press RESET key 5. Check if the magnetic screw is loose or the magnet on windshield cover is fall off
splicing loss is too high	<ol style="list-style-type: none"> 1. The cleaving quality of the fiber is poor 2. Splice parameters unreasonable 3. Arc center offset (rarely occurs) 	<ol style="list-style-type: none"> 1. Re-cleave the fiber 2. Repeat the ARC calibration 3. Repeat the ARC calibration
The ARC does not discharge or has scars	<ol style="list-style-type: none"> 1. The cleaving quality of the fiber is poor 2. The splice parameter is too small 3. The electrodes has adsorbed dust 4. Running data error 	<ol style="list-style-type: none"> 1. Re-cleave the fiber face 2. Increase the cleaning voltage; do ARC calibration again. 3. Clean the electrode with a brush 4. Turn off and restart.
The spliced area becomes thinner	<ol style="list-style-type: none"> 1. Splicing parameters unreasonable, splice voltage is too high 2. Splicing overlap is too small 	<ol style="list-style-type: none"> 1. ARC calibration 2. Increase the amount of splicing overlap
Splicing zone is thicker	<ol style="list-style-type: none"> 1. Splice parameters unreasonable, splice voltage is too small 2. Splicing overlap is too big 	<ol style="list-style-type: none"> 1. ARC calibration 2. Reduce the amount of splicing overlap

Troubleshooting	Reason	Solutions
Splicing has bubbles (usually occurred in the multi-mode fiber splice)	Fiber end with burr, not flat	<ol style="list-style-type: none"> 1. Increase the cleaning voltage 2. Re-cleave fiber
Splicing points have lateral shadows	<ol style="list-style-type: none"> 1. Fiber core does not match (type or core diameter is different) 2. Multimode fiber appear very light shadows after splicing 	<ol style="list-style-type: none"> 1. Re-match the fiber to make the same type of fiber on both sides 2. It is normal, does not affect splice strength and signal transmission quality
Image is tilted	<ol style="list-style-type: none"> 1. Fiber not enter the V-groove completely 2. V-groove is dirt 	<ol style="list-style-type: none"> 1. Re-place the fiber 2. Clean the V-groove with alcohol and brushes
The image is on the top or bottom of the display	<ol style="list-style-type: none"> 1. V-groove is dirt 2. Fiber not enter the V-groove 	<ol style="list-style-type: none"> 1. Clean the V-groove with alcohol and brushes 2. Re-place the fiber
The image is blurred	<ol style="list-style-type: none"> 1. Fiber not enter the V-groove 2. V-groove is dirt 	<ol style="list-style-type: none"> 1. Re-place the fiber 2. Clean the V-groove
Cleave can not cut off the fiber	<ol style="list-style-type: none"> 1. Cladding layer is not stripped 2. Cladding layer stripped too short and the rubber pressure on both sides of the blade did not compress the fiber 	<ol style="list-style-type: none"> 1. Use a Miller clamp to peel off the cladding 2. The length of the stripped cladding should be longer than 30 mm